

■ = Post
≡ ≡ ≡ ≡ =Door to outside

Restrooms
(Not handicap accessible)

Stairs to
Sanctuary

Full
Kitchen

Bifold screen
Pulls out to close
off basement

CHURCH BASEMENT
FLOOR PLAN
28'X31'
(1/4" = 1')

Optional Dressing Area
Closes off with curtains

Mirror

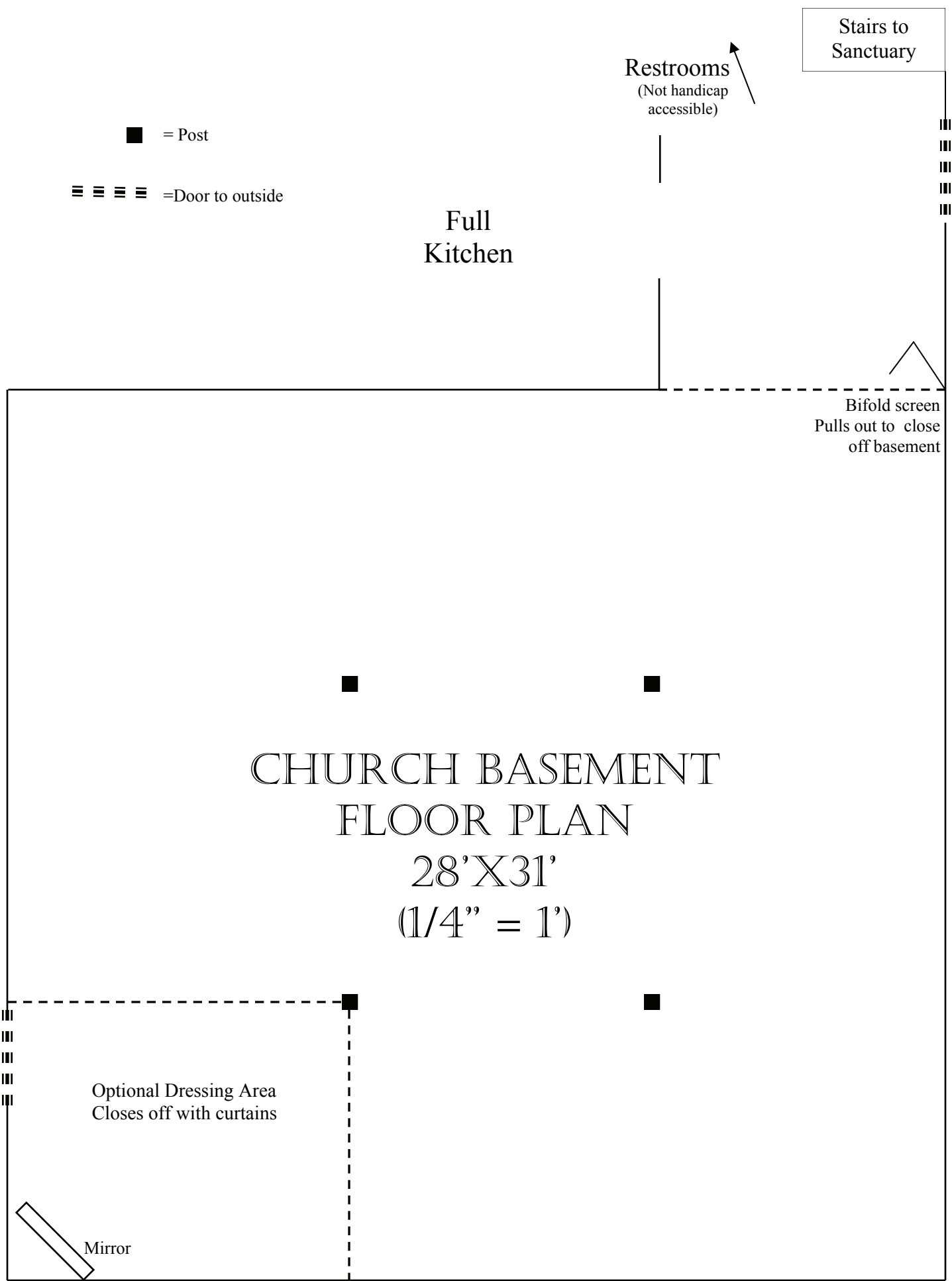

Stairs to
Sanctuary

Restrooms
(Not handicap
accessible)

**Sample MAXIMUM setup
For approx. 65 people**

Kitchen

Guest
book

6'
Gift
Table

6' Table

6' Table

6' Table
Drinks

Buffet

Head table

6' Table

6' Table

6' Table

60"
Tbl

60"
Tbl

60"
Tbl

60"
Tbl

48"
Table

60"
Tbl

48"
Table

48"
Table

48"
cake
table

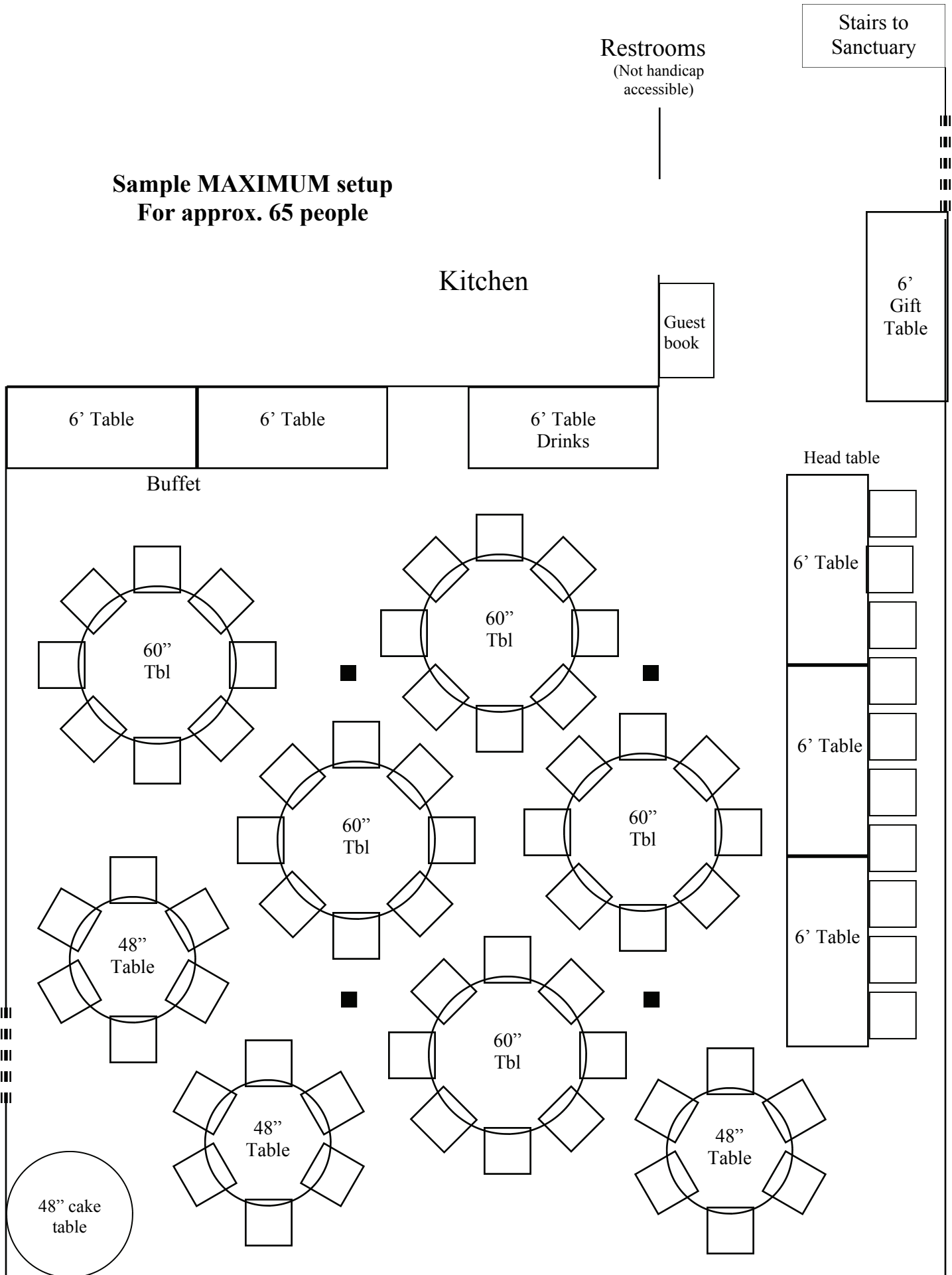

Cut and paste these tables with chairs onto your floor plans
for alternate arrangements
Maximum 6 60" tables, 4 6' tables, 1 8' table

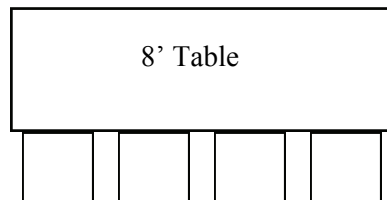
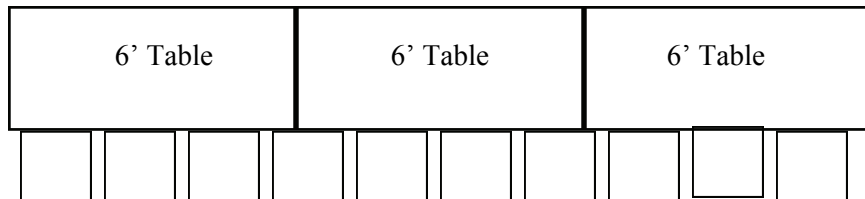
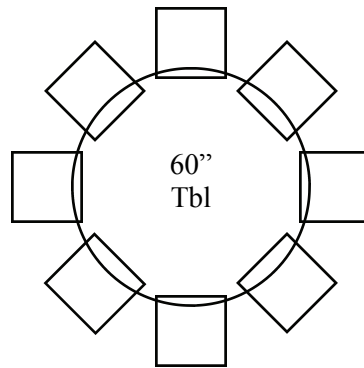
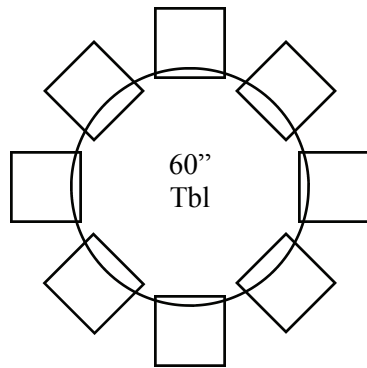
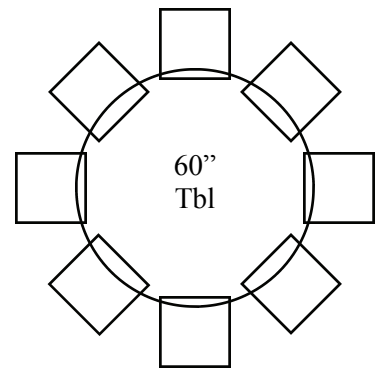
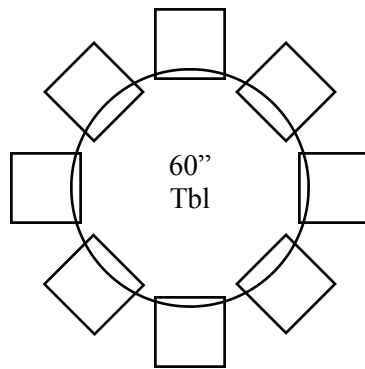
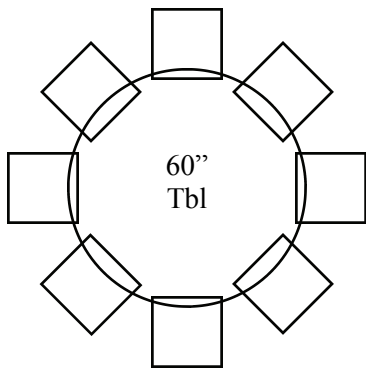
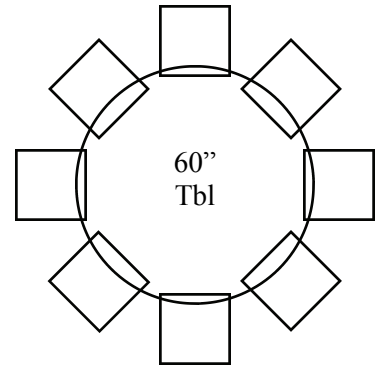
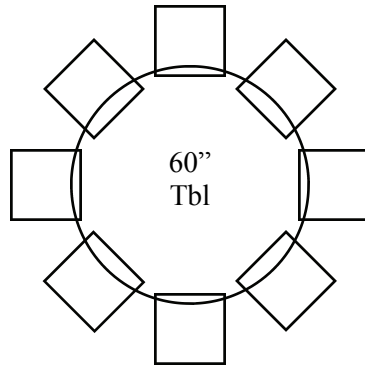
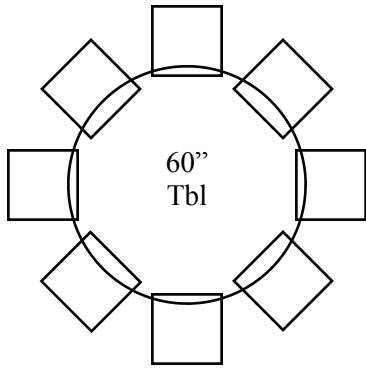

Cut and paste these tables with chairs onto your floor plans
for alternate arrangements
Maximum 15 48" tables

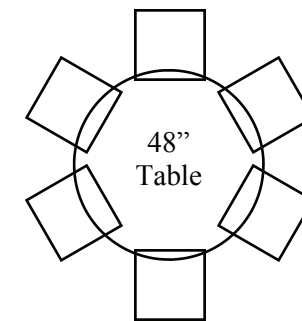
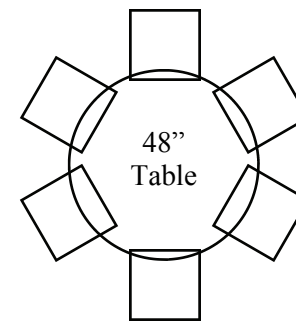
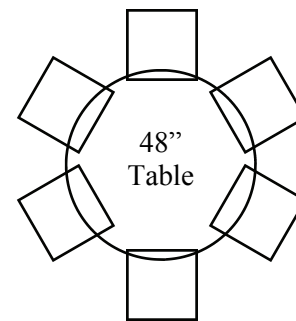
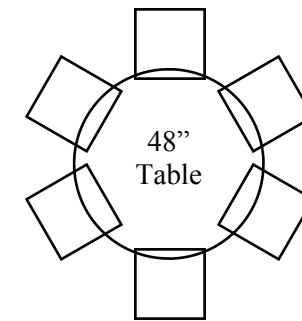
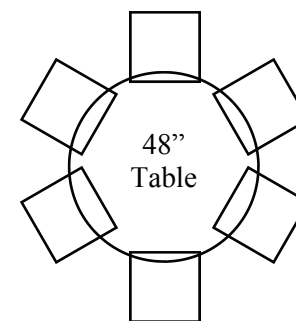
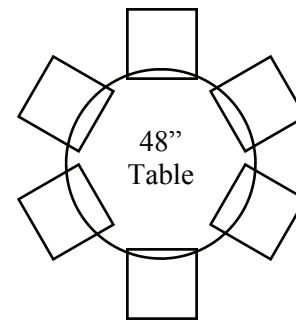
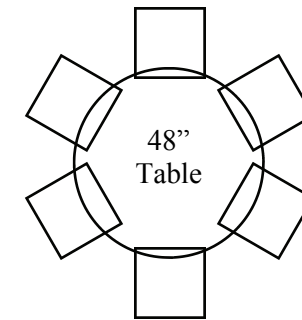
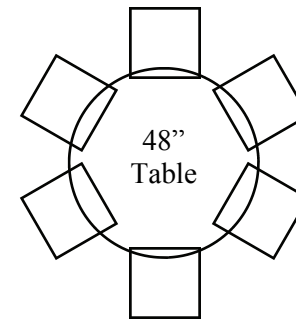
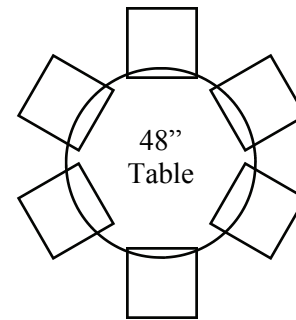
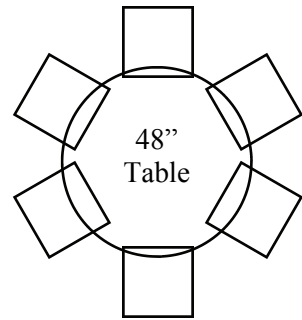
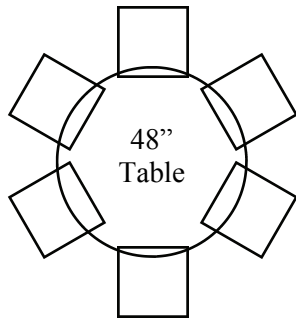
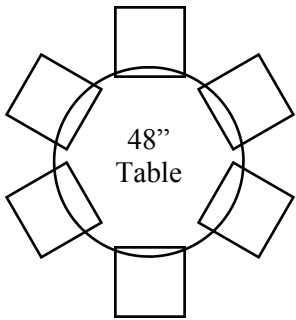
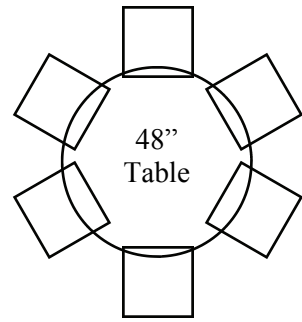
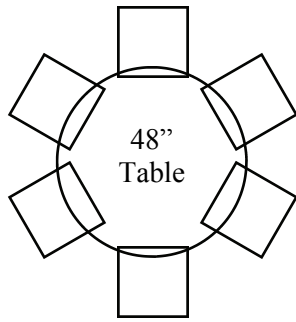
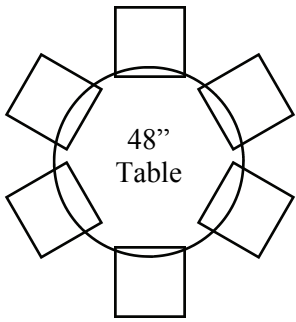

Cut and paste these tables without chairs onto your floor plans
for alternate seating arrangements
Maximum 15 48" tables, 6 60" tables, 4 6' tables, 1 8' table

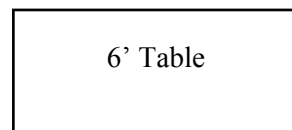
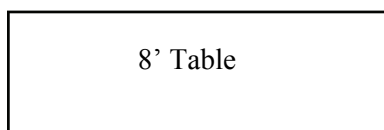
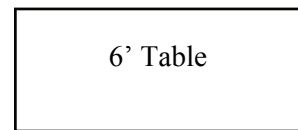
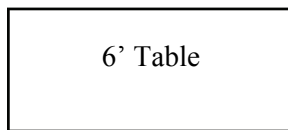
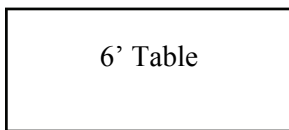
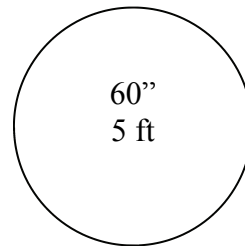
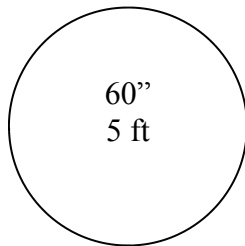
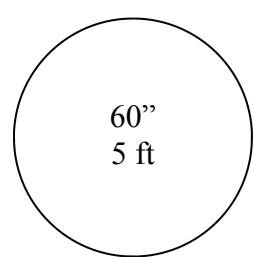
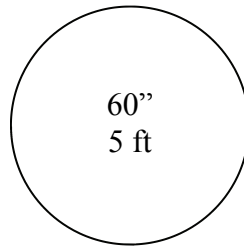
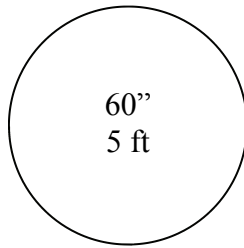
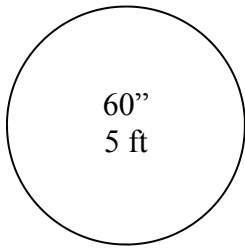
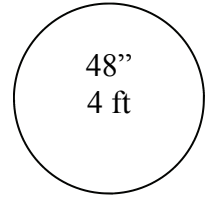
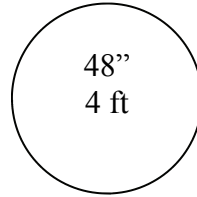
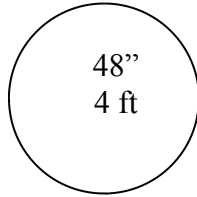
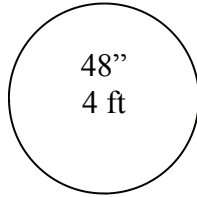
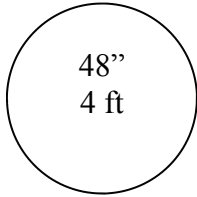
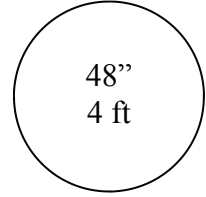
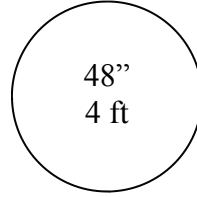
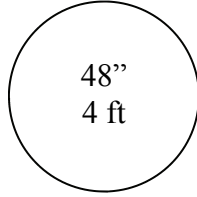
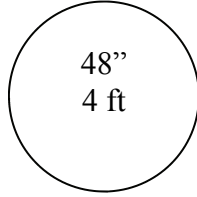
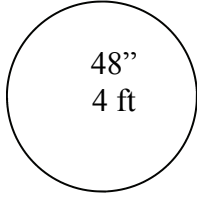
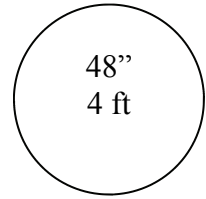
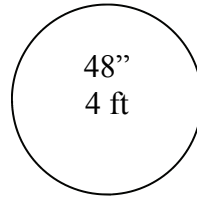
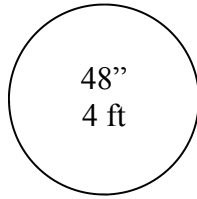
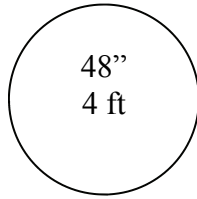
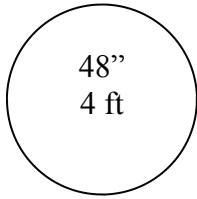

Cut and paste these chairs onto your floor plans
for alternate seating arrangements
Maximum 150 chairs

